

PDF	MODEL: CR-312
	LENGTH: 8'-0"

fiberglass

EDON



EDON CORP.
 1160 EASTON RD.
 HORSHAM, PA 19044
 PH: 215/672-8050
 TOLLFREE: 800/523-2539
 FAX: 215/672-9014
 EMAIL: info@edon.com
 VISIT US @ www.edon.com

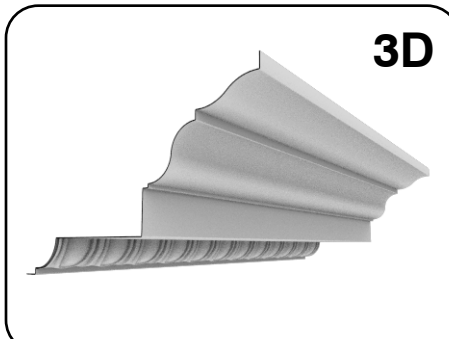

TO VIEW OUR CAD FILES IN .DWG FORMAT, VISIT US ONLINE AND FILL OUT A SHORT FORM TO GAIN ENTRY.